

0.56" SINGLE DIGIT BLUE DISPLAY

A-5161BB

Features

- 0.56 inch digit height
- Blue emitting color
- White segment color, black face
- Low current operation
- Easy mounting on PCB boards or sockets
- Lead free, RoHS compliant

Applications

- Digital clocks
- Electronic meters
- Other electronic devices for displaying numerical information

Ordering Information

| Part Number | Emission Color | Face Color | Bin Code | Luminous Intensity IV (μcd) (IF=10mA) | | |
|-------------|----------------|------------|----------|---|-------|-------|
| | | | | Min. | Typ. | Max. |
| A-5161BB | Blue | Black | T | 26326 | 32907 | 39489 |
| | | | U | 39490 | 49362 | 59235 |
| | | | V | 59236 | 74045 | 88854 |

Maximum Ratings

| Parameter | Symbol | Value | Unit |
|--|-----------|----------|------------|
| Operating temperature | T_{OP} | -35 ~ 85 | °C |
| Storage temperature | T_{STG} | -35 ~ 85 | °C |
| Forward current ($T_A=25\text{ °C}$) | I_F | 30 | mA per seg |
| Peak forward current ($T_A=25\text{ °C}$) * ¹ | I_{PF} | 120 | mA per seg |
| Reverse voltage ($T_A=25\text{ °C}$) | V_R | 5 | V per seg |
| Power consumption ($T_A=25\text{ °C}$) | P | 80 | mW per seg |

*1 at 1/10 Duty Cycle

Electrical / Optical Characteristics (1) $(T_A = 25\text{ °C})$

| Parameter | Symbol | Value | Unit |
|---|-----------------|-------|---------------|
| Wavelength at peak emission (Typ.) | λ_P | 460 | nm |
| Dominant wavelength (Typ.) IF = 20mA | λ_D | - | nm |
| Spectral bandwidth at 50% (Typ.) IF = 20mA | $\Delta\lambda$ | 30 | nm |
| Viewing angle at 50% (Typ.) IF = 20mA | $2\theta_{1/2}$ | - | degree |
| Forward voltage (Min.) IF = 20mA | V_F | 2.8 | V |
| | V_F | 3.2 | V |
| | V_F | 3.5 | V |
| Reverse current (Max.) VR = 5V | I_R | 20 | μA |
| Optical efficiency (Typ.) IF = 20mA | η_{OPT} | - | lm/W |

Luminous Intensity Bin Groups $(T_A = 25\text{ °C} \ \& \ I_F = 10\text{ mA})$

| Bin Code | Luminous Intensity I_v (μcd) | | |
|----------|---|-------|-------|
| | Min. | Typ. | Max. |
| T | 26326 | 32907 | 39489 |
| U | 39490 | 49362 | 59235 |
| V | 59236 | 74045 | 88854 |

Electrical/Optical Charateristic (2)

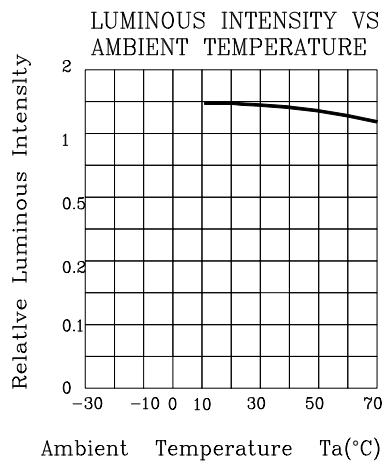
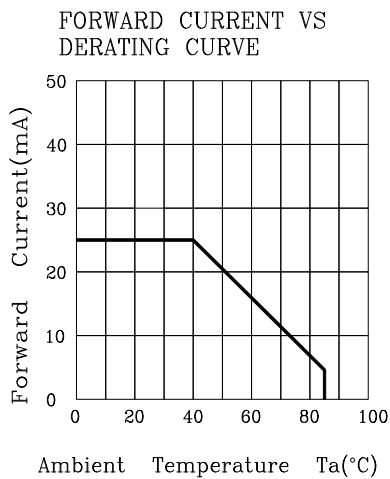
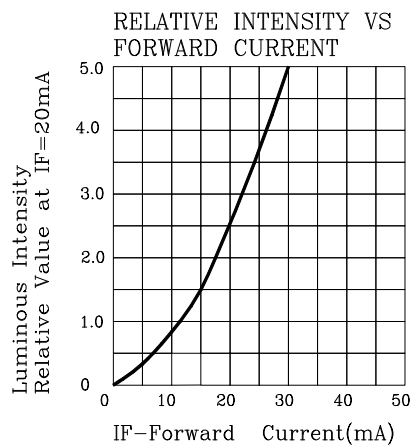
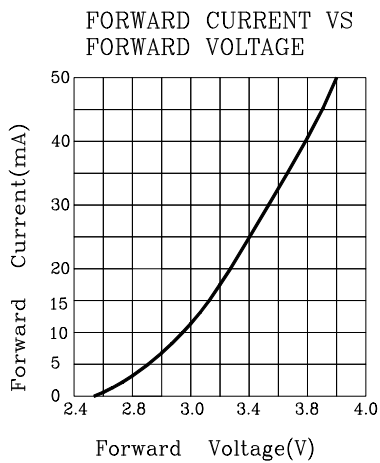
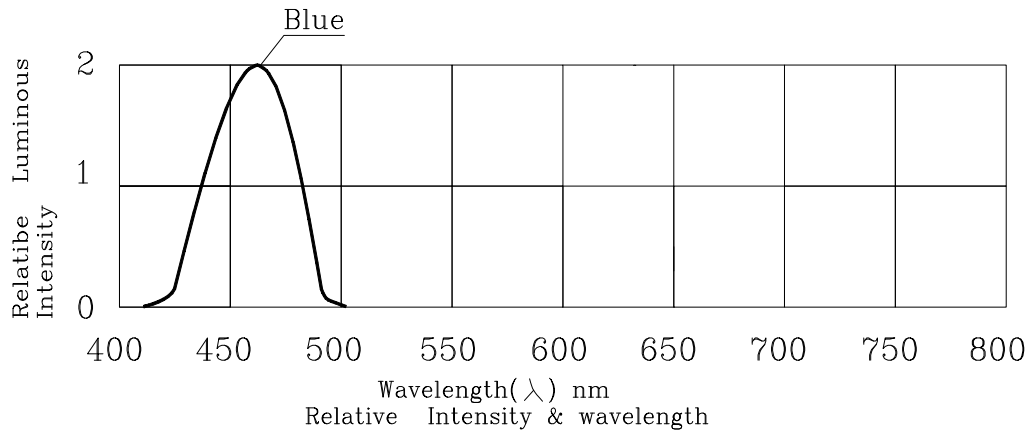

Package Outline Dimensions

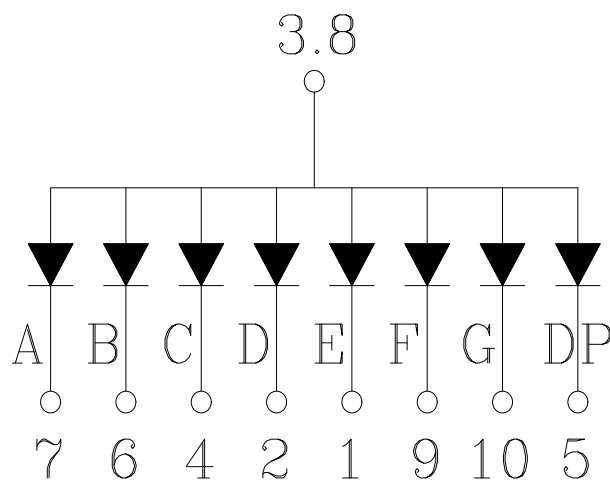
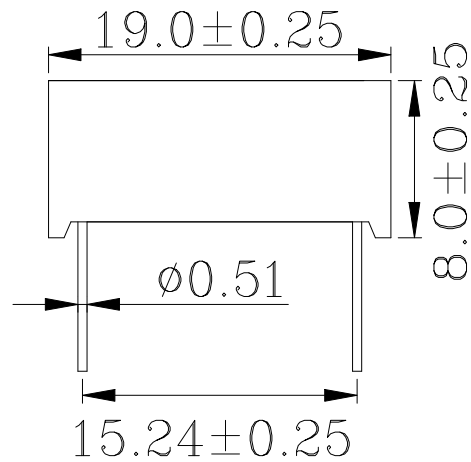
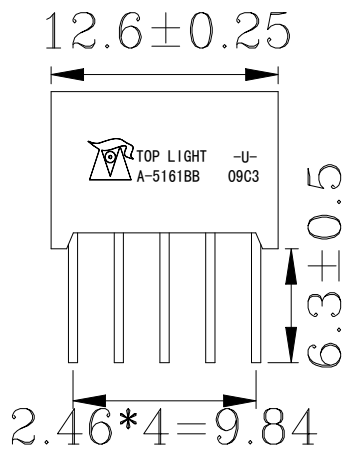
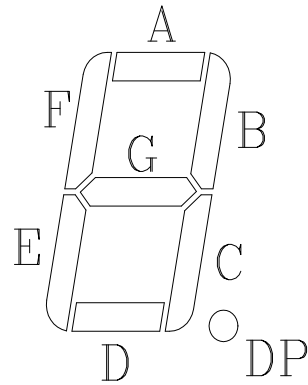
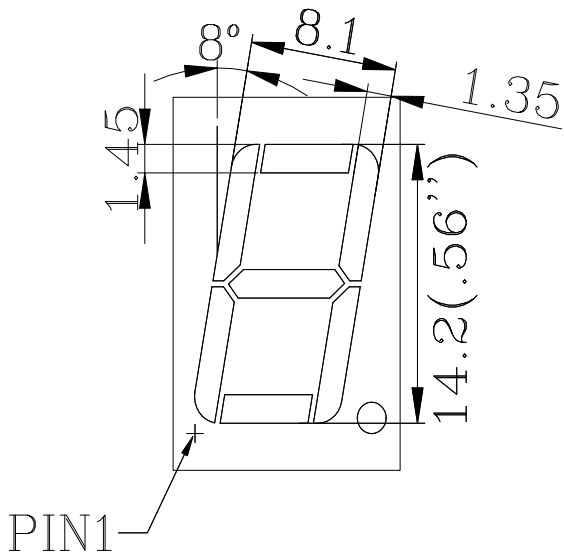

Notes:

1. All dimensions are in millimeters. Tolerance is +/-0.25 unless otherwise noted.
2. The specifications, characteristics and technical data described in the datasheet are subject to change without prior notice.

Display Soldering Conditions

The recommended conditions for soldering are as follows. Because the component is made with epoxy resin, the units are susceptible to heat. Therefore, the preheating and soldering temperatures should be kept as low as possible to avoid damage.

1 . Manual Soldering Conditions(with 1.5mm Iron tip)

Iron Tip Temperature: 350°C Max, Time: 3s Max

Position: The iron should be situated at least 2mm away from the root of the leads.

2 . Through the Wave Soldering Conditions

Wave Soldering Profile For Lead-free Through-hole LED

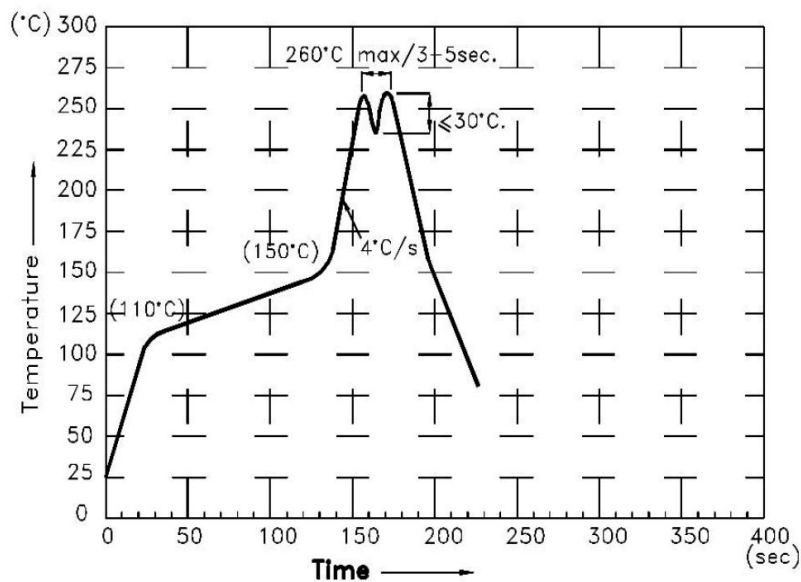

3 . Soldering General Notes:

- Toplight recommend manual soldering to be used only for repair and rework purposes. The soldering iron should not exceed 30W in power. The tip of the soldering iron should not touch the reflector case to avoid heat-damage.
- Maintain the pre-heat and peak temperatures with dip units as low as possible and the times as short as is feasible, since the products are susceptible to heat during flow soldering.
- After soldering, allow at least three minutes for the component to cool to room temperature before further operations.
- If components will undergo multiple soldering processes, or other processes where the components may be subjected to intense heat, please check with Toplight for compatibility.