

# ***SPECIFICATIONS***

FOR TOPLITE COB MODULE

**MODEL: ATP-1818**



**TOPLITE INTERNATIONAL LLC.**

*[www.topliteusa.com](http://www.topliteusa.com)*



## TECHNICAL DATA SHEET

### ATP-1818 <FOR TOPLITE COB MODULE>

## 1. PRODUCT APPEARANCE



## 2. OUTLINE DRAWING

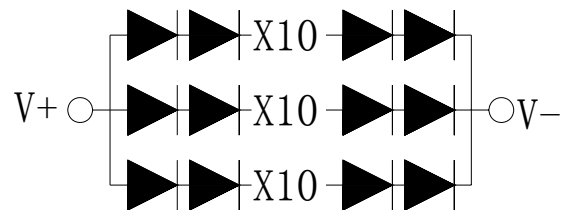
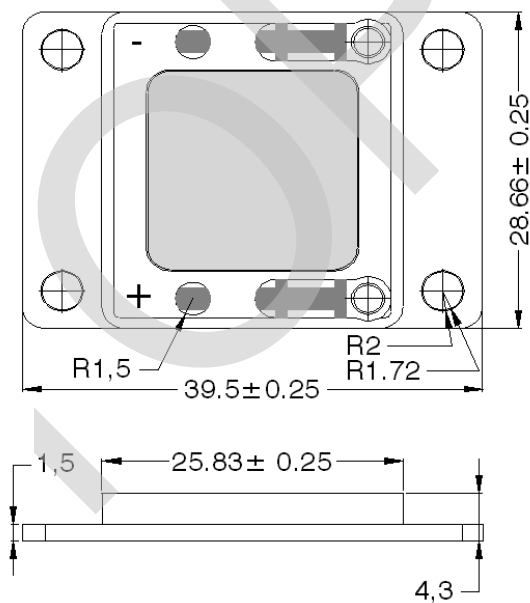

Unit: mm

Tolerance: ±0.25

**TECHNICAL DATA SHEET****ATP-1818** <FOR TOPLITE COB MODULE>**3. PERFORMANCE PARAMETERS****3-1. ABSOLUTE MAXIMUM RATINGS**

ITEM	SYMBOL	RATING	UNIT
Power Dissipation	P	49.5	W
Forward Current	I <sub>F</sub>	1500	mA
Reverse Voltage	V <sub>R</sub>	50	V
Operating Temperature	T <sub>opr</sub>	- 30 ~ + 85	°C
Storage Temperature	T <sub>stg</sub>	- 40 ~ + 100	°C
Junction Temperature	T <sub>jmax</sub>	+ 125	°C

**Note:**

\*1. Forward Current allows maximum surge current  $\leq 10\text{ms}$ .

\*2. Power dissipation and forward current are the values when the LED is used within the range of the derating curve in this data sheet.



**TECHNICAL DATA SHEET**

**ATP-1818** <FOR TOPLITE COB MODULE>

**3-2. ELECTRICAL-OPTICAL CHARACTERISTICS**

(T<sub>c</sub>=25°C)

**	PARAMETER	SYMBOL	CONDITION	MIN.	TYP.	MAX.	UNIT	
common	Forward Voltage <sup>*1</sup>	V <sub>F</sub>	I <sub>F</sub> =1050mA	29	31	33	V	
	Beam Angle	—		—	120	—	Deg	
W	** Color Temp.	—	I <sub>F</sub> =1050mA	2870	3045	3220	K	
	** Color Rendering Index <sup>*3</sup>	R <sub>a</sub>		80	—	—	—	
	W <sub>1</sub>	Luminous Flux <sup>*2</sup>		Φ	2560	2720	—	lm
		Luminous Efficiency		η	80	85	—	lm/W
	W <sub>2</sub>	Luminous Flux <sup>*2</sup>		Φ	2780	3200	—	lm
		Luminous Efficiency		η	87	92	—	lm/W
D	** Color Temp.	—	I <sub>F</sub> =1050mA	4745	5028	5311	K	
	** Color Rendering Index <sup>*3</sup>	R <sub>a</sub>		80	—	—	—	
	D <sub>1</sub>	Luminous Flux <sup>*2</sup>		Φ	2944	3072	—	lm
		Luminous Efficiency		η	92	96	—	lm/W
	D <sub>2</sub>	Luminous Flux <sup>*2</sup>		Φ	3136	3290	—	lm
		Luminous Efficiency		η	98	103	—	lm/W
C	** Color Temp.	—	I <sub>F</sub> =1050mA	6020	6530	7040	K	
	** Color Rendering Index <sup>*3</sup>	R <sub>a</sub>		80	—	—	—	
	C <sub>1</sub>	Luminous Flux <sup>*2</sup>		Φ	3136	3290	—	lm
		Luminous Efficiency		η	98	103	—	lm/W
	C <sub>2</sub>	Luminous Flux <sup>*2</sup>		Φ	3360	3420	—	lm
		Luminous Efficiency		η	105	107	—	lm/W

(Note) Parameters is formulated based on shipping samples

\*1. After 20 ms drive, Measurement tolerance: ± 3 %

\*2. Monitored by TOPLITE's 1 m integrating sphere, after 20 ms drive, Measurement tolerance: ± 10 %

\*3. Monitored by TOPLITE's 1 m integrating sphere, after 20 ms drive, Measurement tolerance:± 2



# TECHNICAL DATA SHEET

## ATP-1818 <FOR TOPLITE COB MODULE>

### 3-3. Characteristics diagram (TYP.)

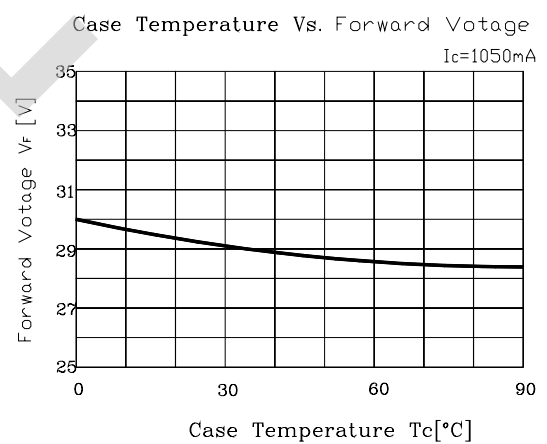
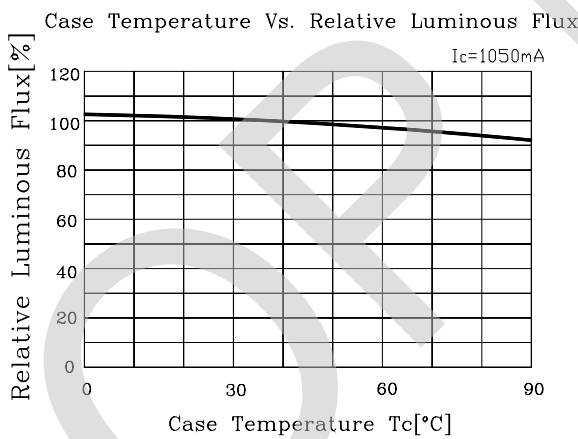
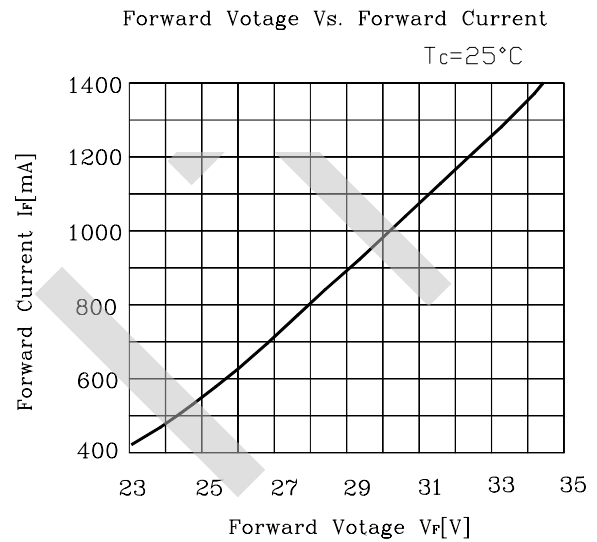
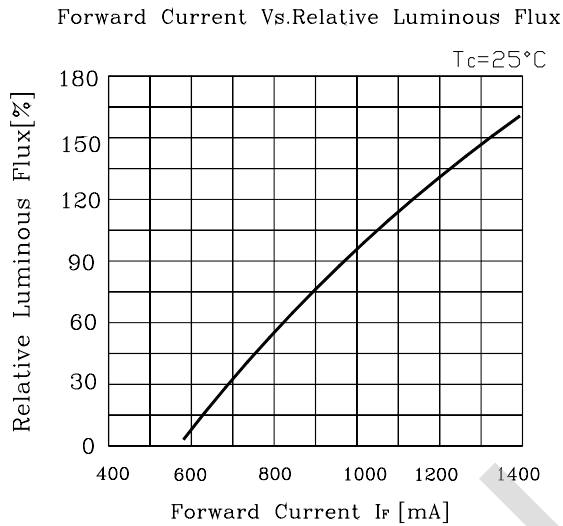

**TECHNICAL DATA SHEET****ATP-1818** <FOR TOPLITE COB MODULE>**4. RELIABILITY**

The reliability of products shall be satisfied with items listed below.

**4-1. TEST ITEMS AND TEST CONDITIONS**

NO.	TEST ITEM	TEST CONDITIONS	RESULT
1	Continuous operation test	$T_a = 25^{\circ}\text{C}$ , $I_F = 1050\text{mA} \times 1000$ hours (with Al fin)	PASS
		$T_a = 80^{\circ}\text{C}$ , $T_j = 120^{\circ}\text{C}$ , $I_F = 1050\text{mA} \times 1000$ hours(with Al fin)	
2	Low temperature storage	$T_a = -40^{\circ}\text{C} \times 1000$ hours	PASS
3	High temperature storage	$T_a = 100^{\circ}\text{C} \times 1000$ hours	PASS
4	Moisture resistance	$T_a = 60^{\circ}\text{C}$ , 90%RH for 1000 hours	PASS
5	Thermal shock	$T_a = -40^{\circ}\text{C} \times 30\text{minutes} \sim 100^{\circ}\text{C} \times 30\text{minutes}$ , 100 cycle	PASS

**4-2. FAILURE CRITERIA**

NO.	PARAMETER	SYMBOL	FAILURE CRITERIA
1	Forward Voltage	$V_F$	$V_F > \text{Initial value} \times 1.1$
2	Luminous Flux	$\Phi$	$\Phi < \text{Initial value} \times 0.7$



**TECHNICAL DATA SHEET**

**ATP-1818** <FOR TOPLITE COB MODULE>

**5. CHROMATICITY COORDINATES REGIONAL**

**5-1. 3000K CHROMATICITY COORDINATES**

(Tolerance:  $x,y \pm 0.005$ )

( $I_F=1050mA, T_c=25^\circ C$ )

Range	Chromaticity coordinates				
	NO.1	NO.2	NO.3	NO.4	NO.5
x	0.4363	0.4305	0.4320	0.4340	0.4377
y	0.4201	0.4206	0.4201	0.4188	0.4180

\* The percentage of each rank in the shipment shall be determined by TOPLITE.

**Chromaticity Diagram**

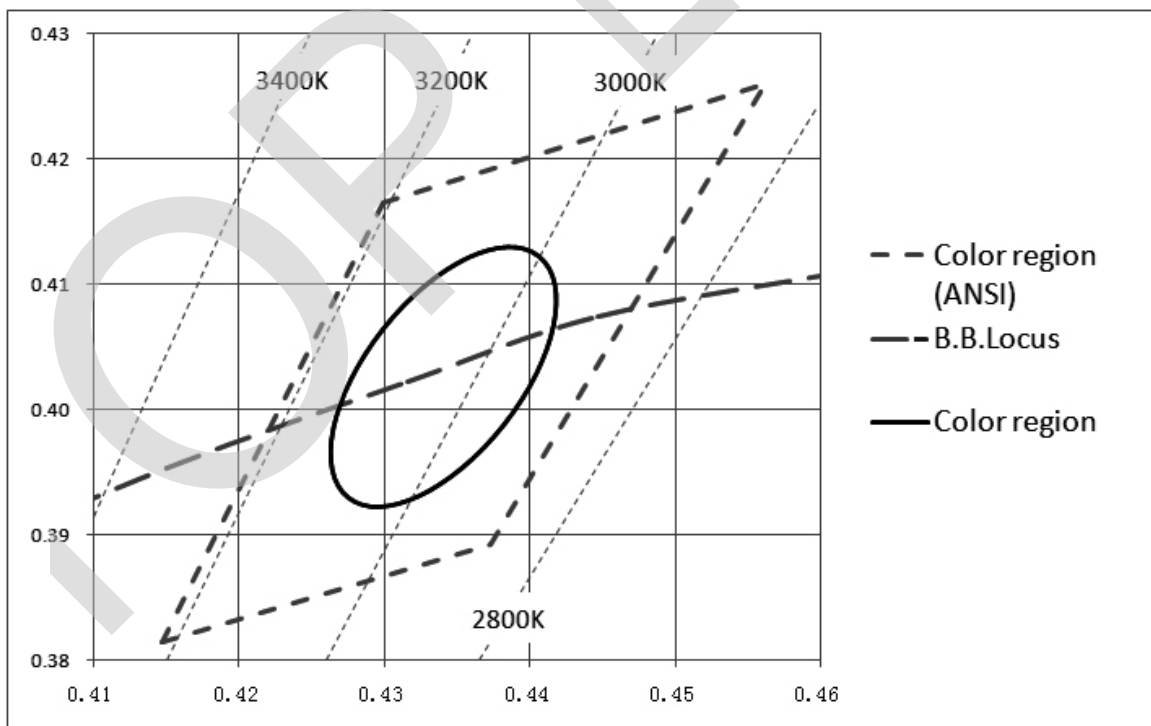

**Note: The tolerance of measurement at our tester is  $V_F \pm 3\%$  ,  $D_v \pm 10\%$  , Chromaticity( $x,y$ ) $\pm 0.005$ .**



**TECHNICAL DATA SHEET**

**ATP-1818** <FOR TOPLITE COB MODULE>

**5-2. 5000K CHROMATICITY COORDINATES**

(Tolerance:  $x,y \pm 0.005$ )

( $I_F = 1050\text{mA}$ ,  $T_c = 25^\circ\text{C}$ )

Range		Chromaticity coordinates				
		NO.1	NO.2	NO.3	NO.4	NO.5
	<b>x</b>	0.3551	0.3376	0.3366	0.3515	0.3551
	<b>y</b>	0.376	0.3616	0.3369	0.3487	0.376

\* The percentage of each rank in the shipment shall be determined by TOPLITE.

**Chromaticity Diagram**

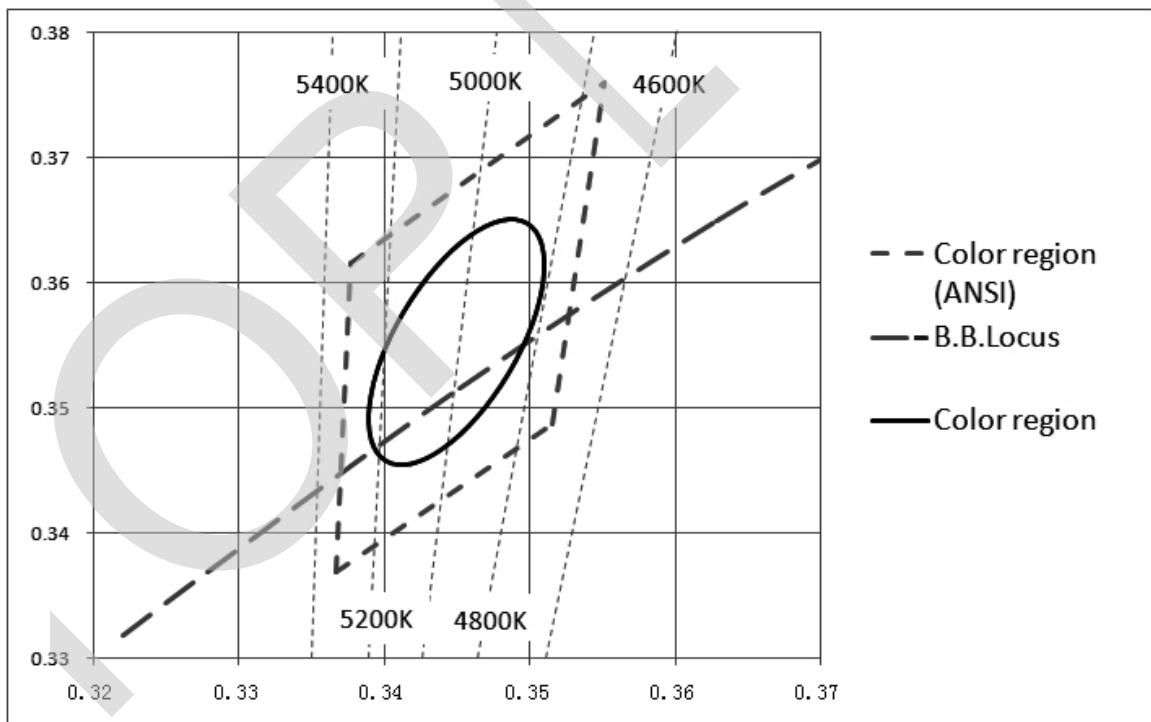

**Note: The tolerance of measurement at our tester is  $V_F \pm 3\%$  ,  $D_v \pm 10\%$  , Chromaticity( $x,y$ ) $\pm 0.005$ .**





**TECHNICAL DATA SHEET**

**ATP-1818** <FOR TOPLITE COB MODULE>

**5-3. 6500K CHROMATICITY COORDINATES**

(Tolerance:  $x,y \pm 0.005$ )

( $I_F = 1050\text{mA}$ ,  $T_c = 25^\circ\text{C}$ )

Range		Chromaticity coordinates				
		NO.1	NO.2	NO.3	NO.4	NO.5
	<b>x</b>	0.3205	0.3028	0.3068	0.3221	0.3205
	<b>y</b>	0.3481	0.3304	0.3113	0.3261	0.3481

\* The percentage of each rank in the shipment shall be determined by TOPLITE.

**Chromaticity Diagram**

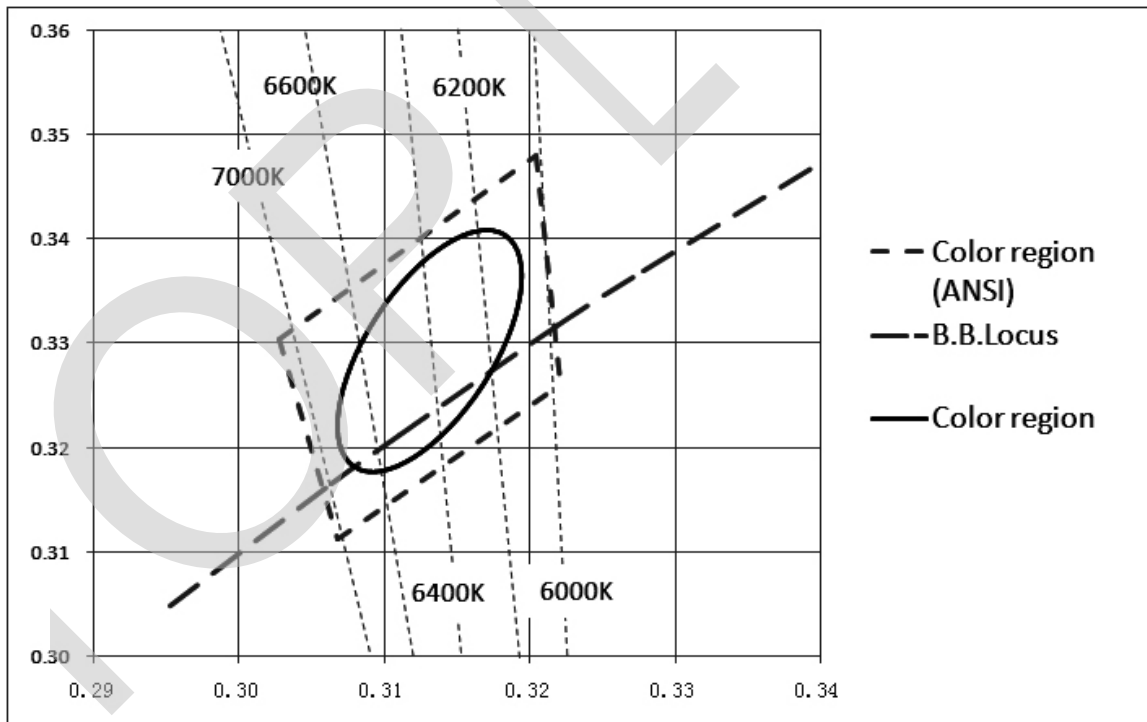

**Note: The tolerance of measurement at our tester is  $V_F \pm 3\%$  ,  $D_v \pm 10\%$  , Chromaticity(x,y)  $\pm 0.005$ .**